

# CYLINDER

C O L L E C T I O N

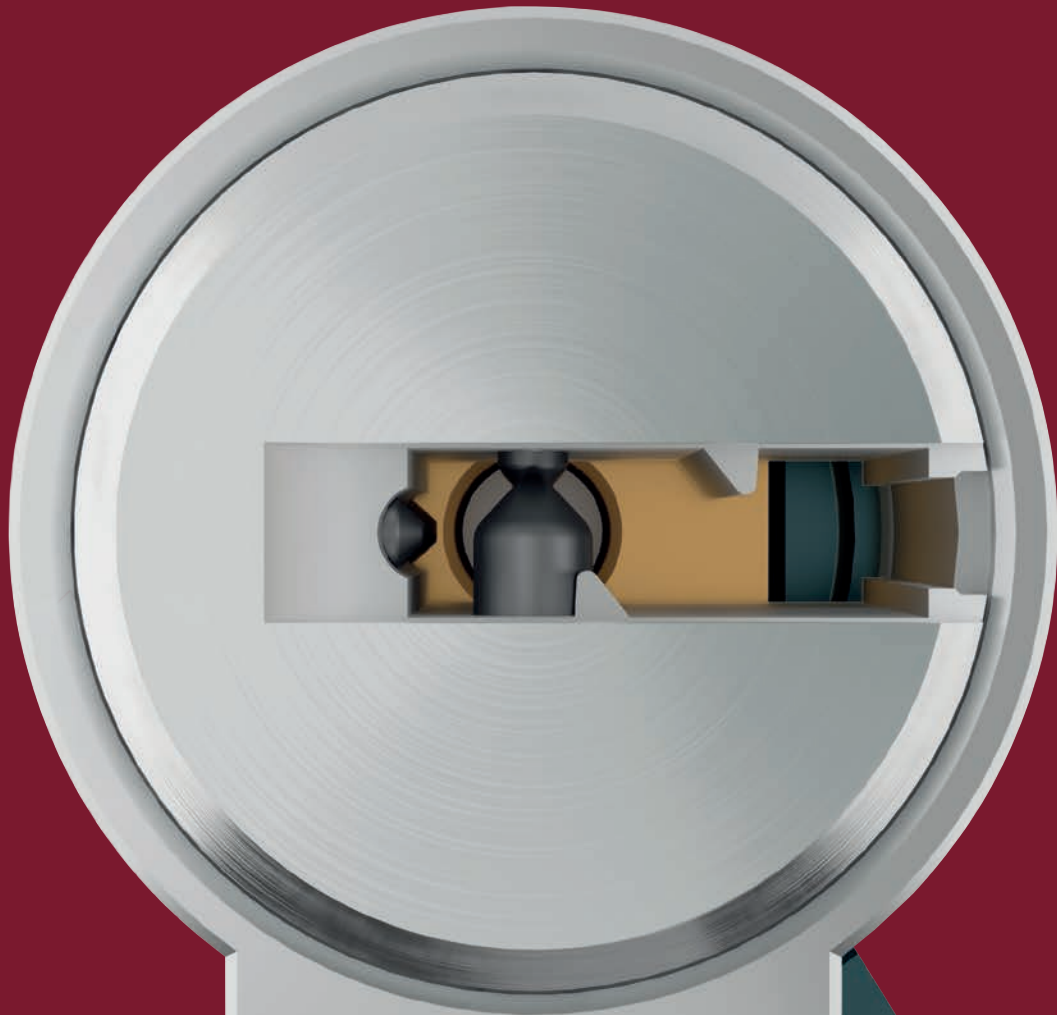

**AGB**<sup>®</sup>

Open, Close, Live

# Index

---

<b>12</b>	Scudo DCK
<b>14</b>	Genio
<b>16</b>	U-Tech PS
<b>18</b>	5000 PS
<b>20</b>	Mod. 600
<b>22</b>	Available Finishes
<b>23</b>	Full range
<b>23</b>	Customisation
<b>24</b>	Keying systems
<b>28</b>	Guide to cylinder selection
<b>30</b>	Comparative table of cylinders according to UNI EN 1303 and UNI EN 1627 standards



## Made in Italy

---

AGB offers a complete range of cylinders and accessories designed to meet all security and access control requirements, from solutions for new installations to high-security cylinders.

Our cylinders are entirely engineered and manufactured in Italy, at our dedicated plant in Pove del Grappa. All cylinders have passed the rigorous certification tests required by the European standard UNI EN 1303 with excellent results, ensuring strength, reliability and long-term durability in compliance with the highest security standards.



100% Made in Italy



Dedicated manufacturing plant



Cylinders tested and certified to UNI EN 1303

# TECHNOLOGY

Innovation and Quality



## Extreme precision

---

Every component of the cylinder is crafted with meticulous attention to detail, while advanced manufacturing technologies guarantee a **superior quality** product.

The result is a precise mechanism that delivers smooth, reliable performance with every turn of the key.



Advanced manufacturing technologies



Attention to details



High quality

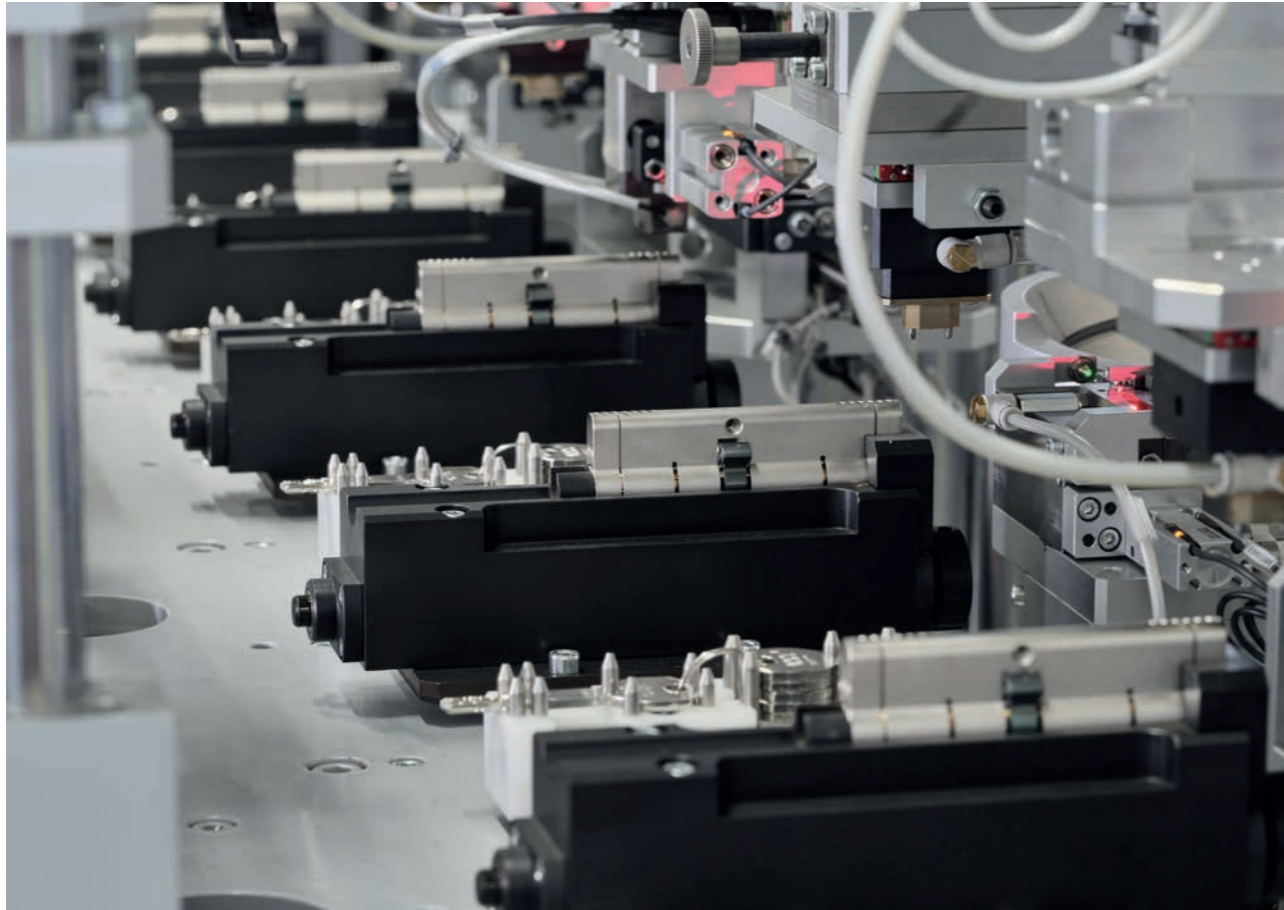

## Automated assembly

---

The dedicated production plant, continuous investment in **automated production** lines and highly specialised personnel ensure short lead times worldwide.

The advanced technological research and direct control of the entire production process enable us to offer customised solutions to meet the specific needs of each customer.



Advanced technological research



Automated production lines



Short delivery times

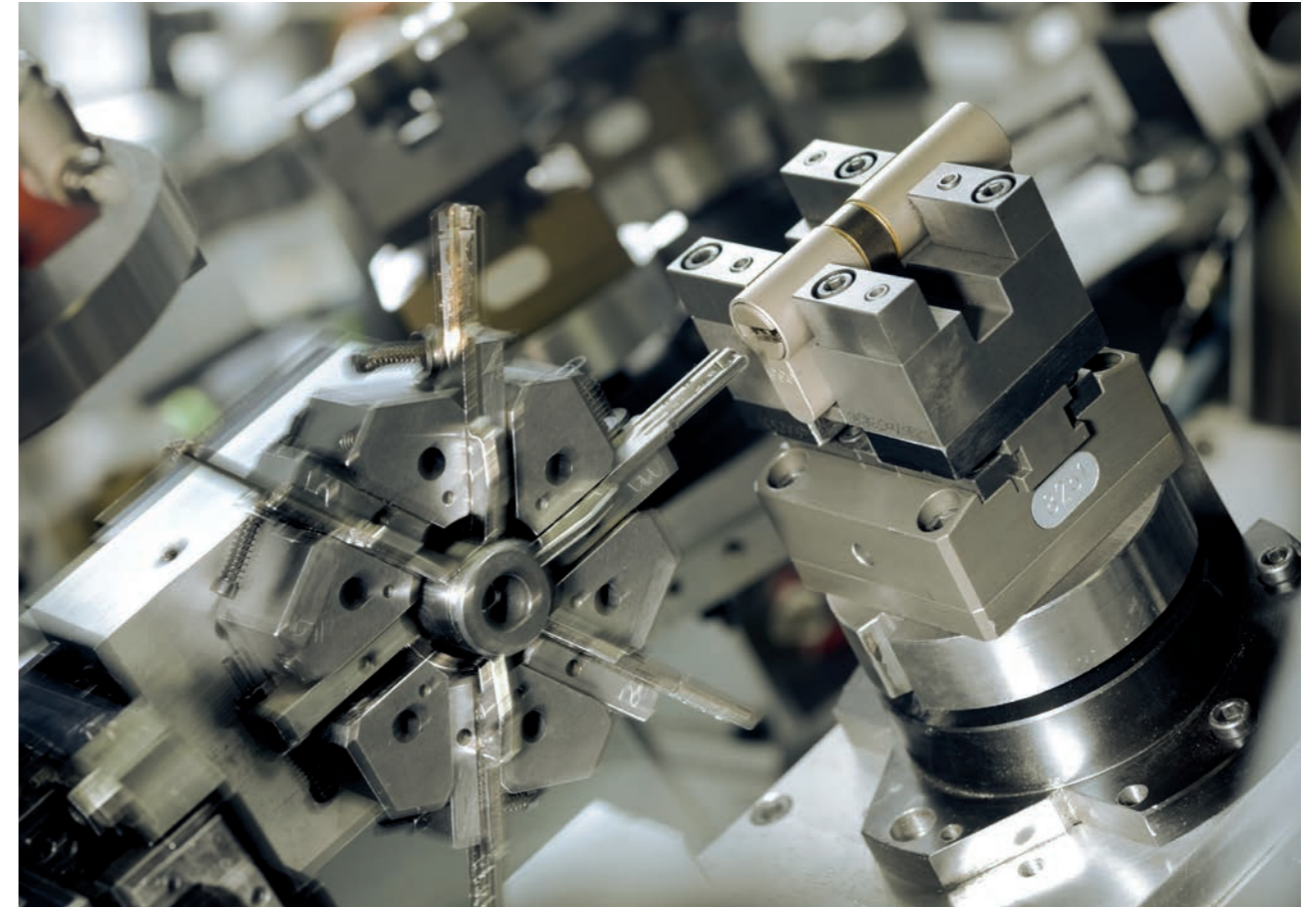

## Automated testing

---

Our cylinders undergo **rigorous controls** at every stage of the production process.

Each cylinder is individually tested before packaging. Thanks to automated control systems that simulate manual key rotation, we verify the correct operation of every cylinder to guarantee maximum reliability.



Cylinders tested in AGBLab



Automated quality controls

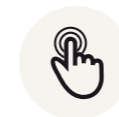

Tested one by one

# SECURITY

Protection and reliability



## AGB cylinders, a guarantee of security

The cylinder is the first barrier against break-in attempts.

AGB cylinders feature advanced technologies, ensuring high **security** performance to protect your home.



High bumping resistance



Anti-drill pins in hardened steel



Anti-snap protection

## AGB keys, billions of combinations

The higher the number of combinations, the greater the guarantee of a unique key. Multiple combinations enable the management and control of multi-access environments through the development of master key systems.



Controlled duplication



Ergonomic grip



Key system management

# SCUDO DCK

High-security cylinder with keys duplicable only by AGB upon presentation of a secret PIN code

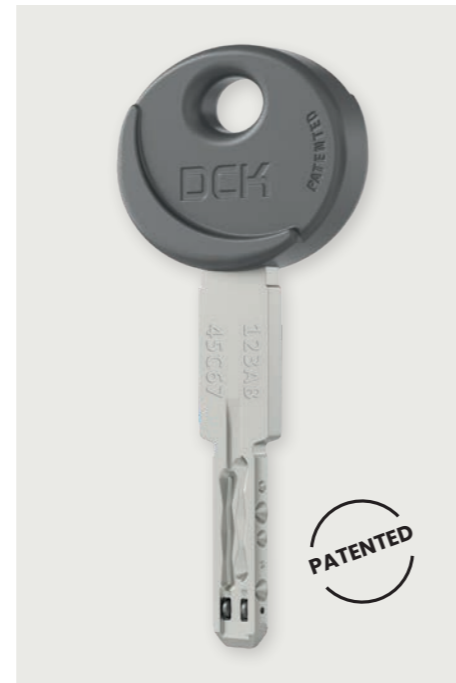

## DCK cylinder

The DCK cylinder features **radial pin technology**, ensuring a high number of key combinations and excellent resistance to manipulation.

Anti-drill reinforcements on the body and plug, anti-snap bar, and anti-pull protection provide a high level of security against break-in attempts, in compliance with EN 1303 standards.

The cylinder is supplied as standard with 5 keys and 3 unique PIN codes for key duplication.

## DCK key

The **key in nickel silver** is reversible and features **moving elements** that enhance its security level.

The 21 mm key neck ensures compatibility with protective escutcheons, while the ergonomic grip improves handling comfort.



## Controlled duplication

The key is **patent-protected**: only the manufacturer is authorised to produce key blanks and provide duplicates upon customer request.

To request duplication, it is necessary to contact an authorised AGB dealer and present the secret PIN code.



## European profile cylinder EN 1303:2015

ICIM	Key security	1	2	3	4	5	6
	Durability	1	2	3	4	5	6
	Attack resistance	0	A	B	C	D	



Anti-picking	Pass
	Level: 1 2 3
Anti-bumping	Level: 1 2 3

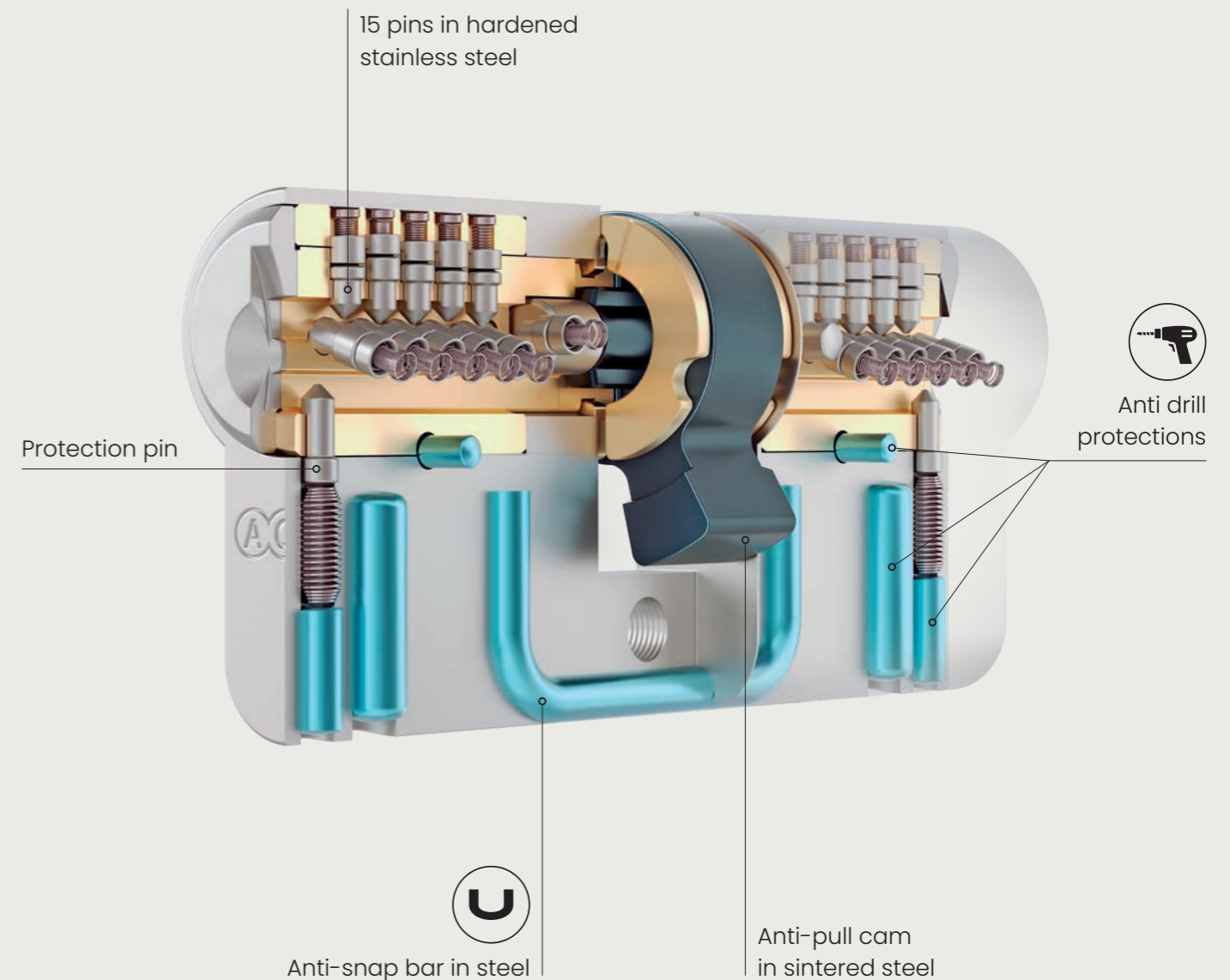

## High security cylinder with controlled key duplication



### Genio cylinder

Genio is **certified** against the most common types of break-ins at the **highest level**.

In torsion attacks, the sacrificial cut allows the controlled snapping of the cylinder, to remove the burglar's grasping point while preserving the functional core.

Hardened steel anti-drill protection prevent drilling, blocking attacks from the most aggressive drill bits. Picking and bumping protection systems ensures a high level of resistance against both types of opening techniques. When key is removed, the cylinder bitting is not decodable thanks to the pin shape. The high number of pins also enables **millions of different key combinations**.

### Controlled duplication

The key is protected by **patent**: only AGB can produce the blanks and distribute them to authorized **AGB Genio Point**.

For key duplication, it is necessary to contact an AGB Genio Point and present the key together with the **Security Card**.



### Genio key

It is a **reversible key** in nickel-plated brass, with an ergonomic non-slip grip.

The 17 mm key neck ensures compatibility with most protective escutcheons.

The key is available in **customized profiles** with regional exclusivity. As standard, the cylinder is supplied with 3 or 5 keys and the Security Card, in sealed packaging.

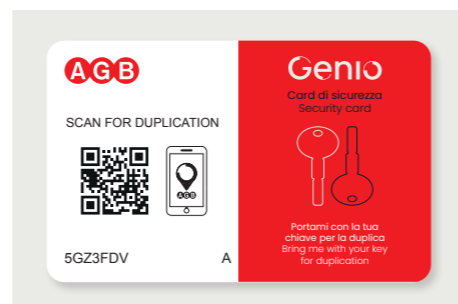

## European profile cylinder EN 1303:2015



Key security	1	2	3	4	5	6
Durability	1	2	3	4	5	6
Attack resistance	0	A	B	C	D	



Anti-picking **Pass**

Anti-bumping Level: 1 2 **3**

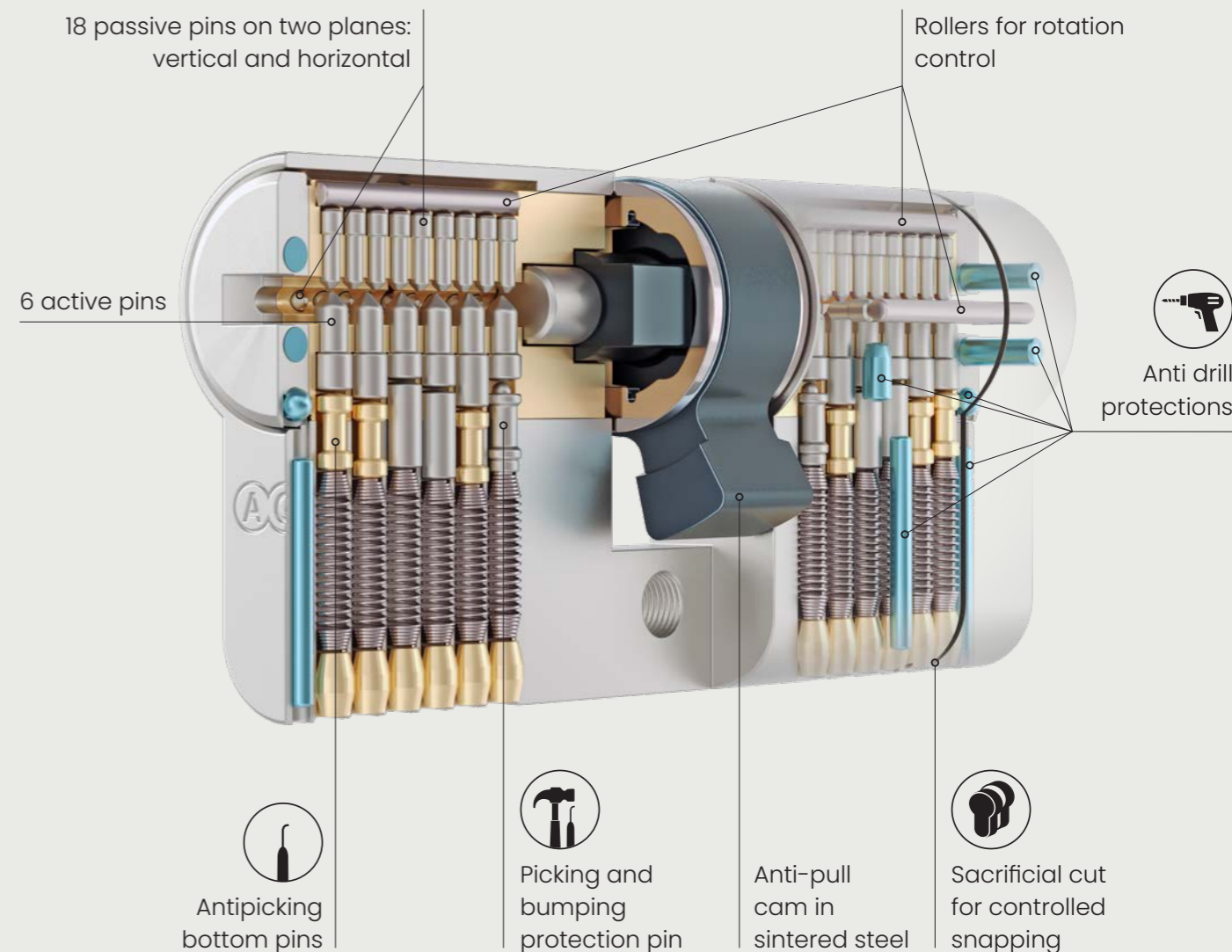

## Reinforced security cylinder with reversible flat key



### U-Tech PS cylinder

The U-Tech PS security cylinder is based on a solid 6 vertical active pin technology, integrated with two control lines with 4 and 5 passive pins.

**Anti-snap reinforcement**, anti-drill pins, and anti-pull protection ensure a high level of security against break-in attempts, in compliance with the EN 1303 standard. Stainless steel pins ensure long-term durability and corrosion resistance.

The product is supplied as standard with 5 keys and a Security Card for key duplication, in sealed packaging.

The key-key version is equipped with a clutch system as standard, allowing opening from the outside even when a key is inserted on the inside.

### U-Tech PS key

It is a **reversible key** in nickel-plated brass, with an ergonomic grip.

Optional coloured caps are available for easy key differentiation.



Optional coloured key cap.

### Key duplication

Key duplication is possible exclusively at authorised centres, upon presentation of the **Security Card** together with the key to be duplicated.

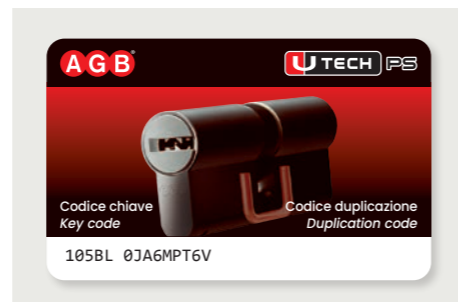

### European profile cylinder EN 1303:2015

ICIM	Key security	1	2	3	4	5	6
	Durability	1	2	3	4	5	6
	Attack resistance	0	A	B	C	D	

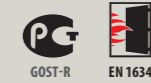

Anti-picking	Pass
	Level: 1 2 3
Anti-bumping	Level: 1 2 3

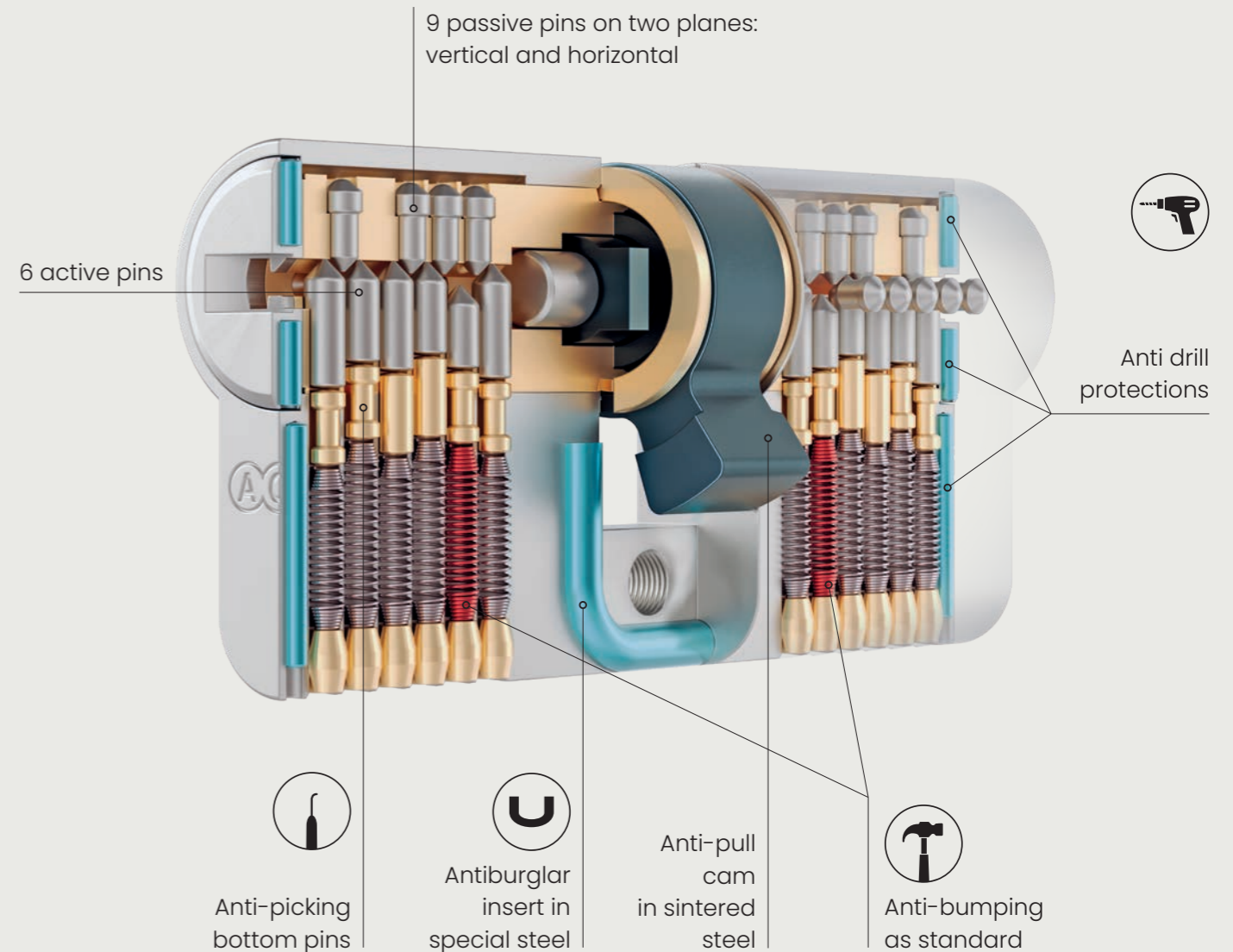

# 5000 PS

## Security cylinder with reversible flat key



### 5000 PS cylinder

The 5000 PS cylinder is based on a **solid 6 vertical active pin technology**, integrated with two control lines with 4 and 5 passive pins.

It is an affordable solution that guarantees **good performance**, offering protection against the most common break-in attempts.

It is supplied as standard with 5 keys in sealed packaging.

The anti-drill and anti-pull protection and the shape of the internal components ensure good resistance to forced entry.



### 5000 PS key

It is a **reversible key** in nickel-plated brass.

Optional coloured caps are available for easy key differentiation.



Optional coloured key cap.

## European profile cylinder EN 1303:2015



Key security	1	2	3	4	5	6
Durability	1	2	3	4	5	6
Attack resistance	0	A	B	C	D	

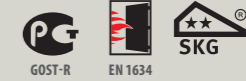

Anti-picking	Pass
Anti-bumping	Level: 1 2 3

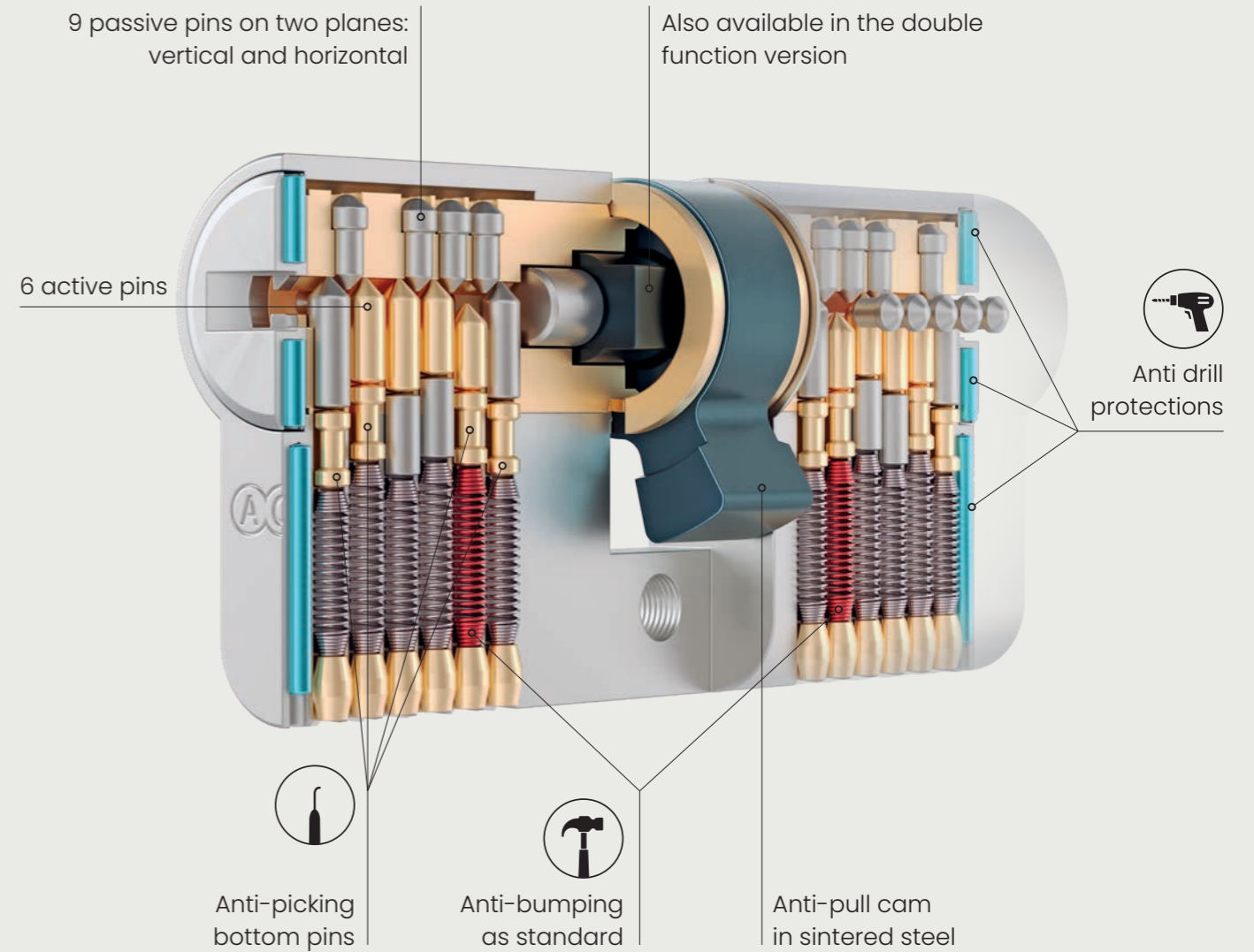

# 600

## Cylinder with profiled key



### 600 cylinder

The 600 cylinder is based on **solid 5 vertical brass pin technology**.

The precise engineering of tolerances and fits ensures **consistent reliability** even in the most demanding applications.

It is the ideal solution for interior doors, available in different color finishes to suit any design requirement.

The product is supplied as standard with 3 keys.

### 600 key

The key in nickel-plated brass features a **paracentric profile**.

### European profile cylinder EN 1303:2015



Key security	1	2	3	4	5	6
Durability	1	2	3	4	5	6
Attack resistance	0	A	B	C	D	



GOST-R



EN 1634



Anti-picking

Pass

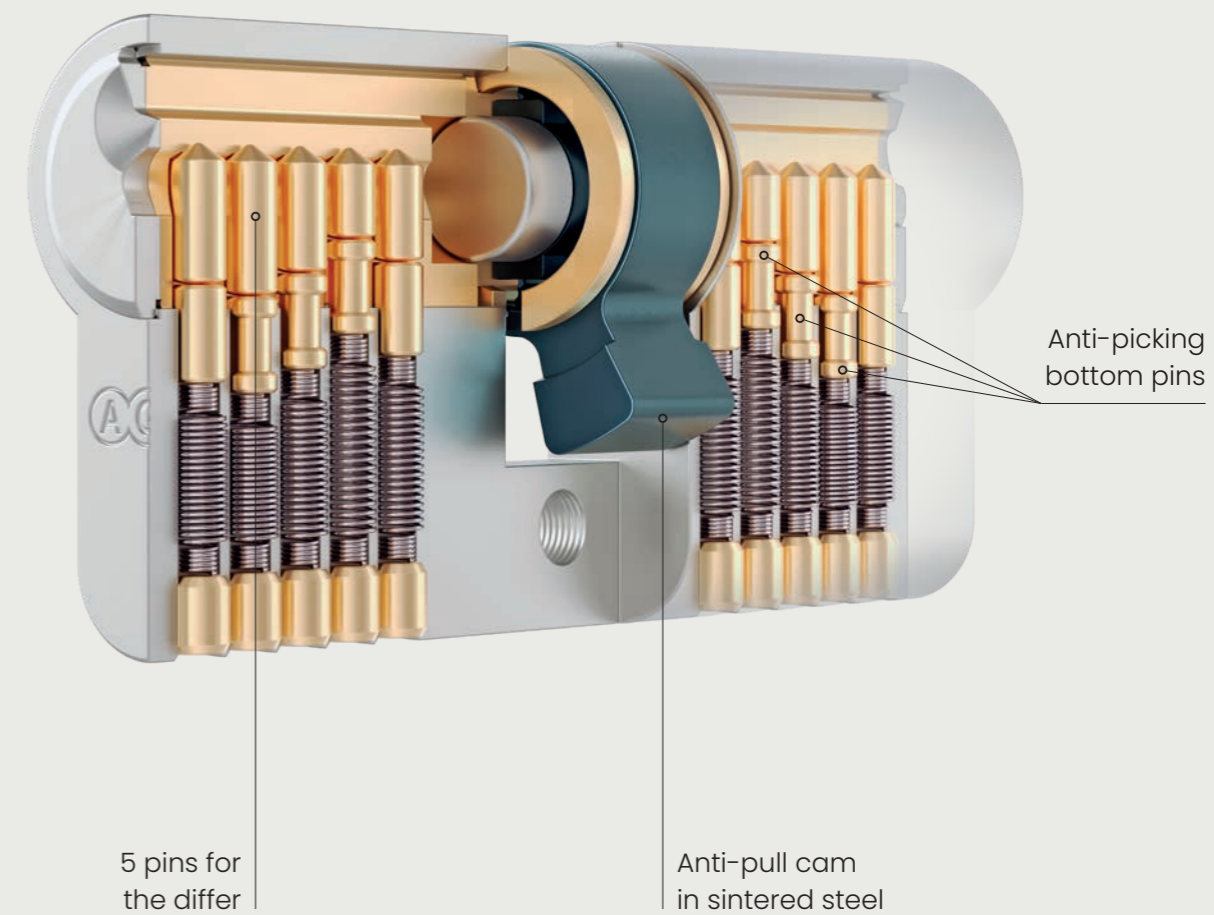

# Available Finishes

- 01** Plain
- 08** Satin
- 10** Enamelled
- 02** Bronze plated



- 84** Matt black
- F9** Glossy black titan
- 12** Antique brass glossy
- 72** Antique brass matt



- 06** Nickel plated
- 32** Satin chromium plated
- 13** Satin nickel plated
- 36** Brushed stainless steel



- 30** Chromium plated
- 34** Matt chromium
- 16** Matt nickel
- 26** Mineral grey (\*)



(\*) Only for Genio cylinder.



Finishes are also available for knob versions.

# Full range

		SCUDO DCK	GENIO	U-TECH PS	5000 PS	MOD. 600
key-key						
key - key double function						
half cylinder - key						
knob - key						
18 or 63 mm tang - key						
knob - emergency cylinder						
half cylinder - knob						

## PASS KEY



The Pass Key is available on request: the Pass Key is automatically deactivated the first time one of the owner keys is used. Please refer to the current price list for availability.

# Customisation

All AGB cylinders can be customized to meet your needs.

Tailor-made cylinders... for all types of doors!



up to 175 mm on each side, at 5 mm intervals

# Keying systems

## MK Master key system

Each cylinder is opened by its own key, which cannot open any other cylinder in the system. All cylinders can be opened by the master key MK.

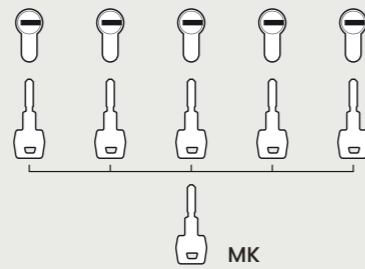

## CC Central cylinder system

Each cylinder is supplied with its own key, which cannot open any other cylinder in the system. All keys of the system can open the central lock cylinder.

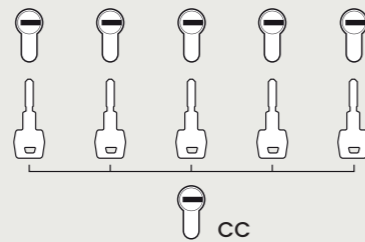

## CCMK Central cylinder system and master key

Each cylinder is supplied with its own key, which cannot open any other cylinder in the system except the central cylinder. All cylinders can be opened by the master key MK.

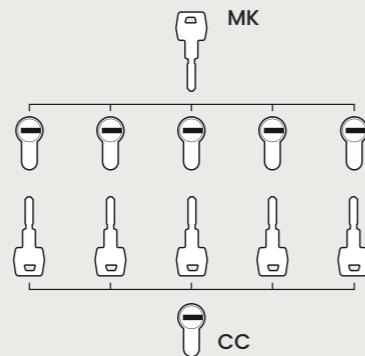

## KA system, ideal for residential use

### Keyed alike system

All cylinders have the same coding and can therefore be opened by the same key.

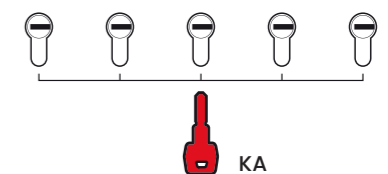

*1 key,  
opens all the doors!*



# GMK system, for offices and public buildings

## General master key system



Similar to a master key system, but with cylinders organised into two or more groups. Each group can be opened by its own group master key MK.

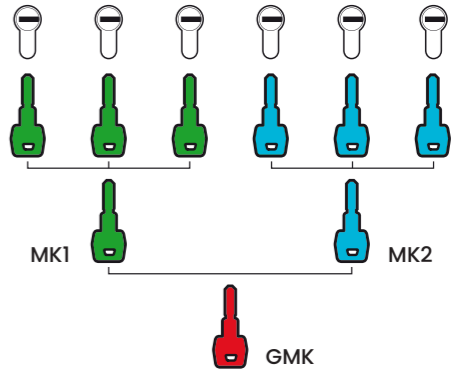

All cylinders in the system can be opened by the general master key GMK.

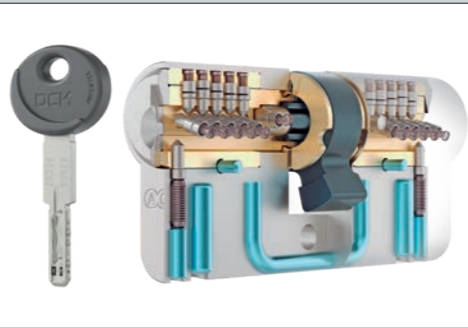
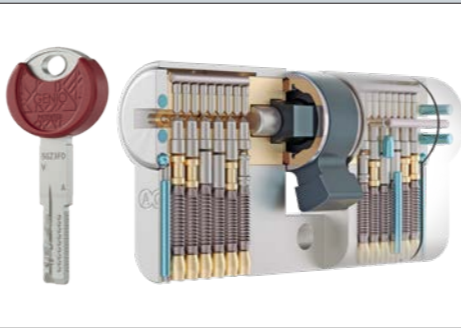

Smart access management

# Guide to cylinder selection

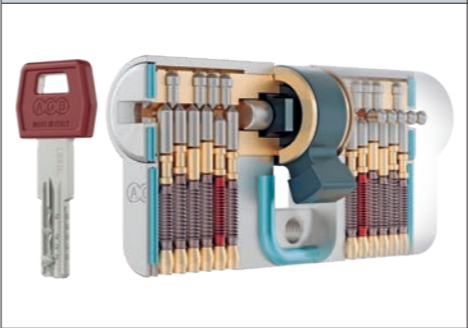
		SCUDO DCK	GENIO
			
FEATURES	Number of keys included	5	3/5
	Pass key	-	As standard
	Key material	Nickel silver	Brass
	Property card	3 unique secret PINS	Security card
	Key duplication	Only at AGB	Only at Genio Point
	Double function	Optional	Si
SECURITY	Key security <b>EN 1303</b>	6	6
	Durability <b>EN 1303</b>	6	6
	Attack resistance <b>EN 1303</b>	D	D
	Anti-picking 	Pass	Pass
	Anti-bumping 	Level 2	Level 3
	Anti-pull	Yes	Yes
	Anti-drill	Yes	Yes
	Controlled snap	No	Yes
	Anti-snap reinforcement	Yes	No

		U-TECH PS	5000 PS	MOD. 600
				
		5	5	3
		Optional	Optional	-
		Brass	Brass	Brass
		Security card	-	-
		Free duplication	Free duplication	Free duplication
		Si	Optional	No
		6	6	3
		6	6	6
		D	0	0
		Pass	Pass	Pass
		Level 2	Level 2	-
		Yes	Yes	Yes
		Yes	Yes	No
		No	No	No
		Yes	No	No

# Comparative table of cylinders according to UNI EN 1303 and UNI EN 1627 standards

CYLINDERS RANGE	UNI EN 1303:2015 - ICIM 0039CS - IMPORTANT INFORMATION					UNI EN 1303 CERTIFICATE	UNI EN 1627:2021			
	digit 2	digit 4	digit 6	digit 7	digit 8		Resistance class			
	Durability	Fire resistance	Corrosion resistance	Key security	Attack resistance		a	b	c	d
							RC1-RC1N	RC2-RC2N-RC3	RC4	RC5-RC6
SCUDO DCK	6	B	C	6	D	●	●	●	●	To be tested according to UNI EN 1630:2021
GENIO	6	B	C	6	D	●	●	●	●	
U-TECH PS	6	B	C	6	D	●	●	●	●	
5000 PS	6	B	C	6	0	●				
Mod. 600	6	B	C	3	0	●				

Highest reachable result on the tests.

## UNI EN 1303:2015 - ICIM 0039CS

### ACCESSORIES FOR WINDOWS AND DOORS - CYLINDERS FOR LOCKS - REQUIREMENTS AND TEST METHODS

- Category of use** - Grade 1: for use by people with high knowledge of operation and little chance of misuse.
- Durability** - Measured in 3 grades, from 4 to 6. The scale indicates the number of opening/closing cycles the cylinder is tested on. At Grade 6, the cylinder has reached 100,000 cycles.
- Door mass** - Grade 0: the only grade provided, no test required.
- Fire resistance** - Grade 0: not suitable for fire and smoke doors. Grade A: suitable for fire doors. Grade B: suitable for fire and smoke doors.
- Security** - Grade 0: the only grade provided, no test required.
- Corrosion resistance** - Measured in 4 grades: 0-A-B-C. To reach the maximum Grade C, the cylinder is tested under thermal shocks from -25°C to +65°C and 96 hours of salt spray test according to grade 3 of UNI EN 1670.
- Key-related security** - Measured in 6 grades, from 1 to 6, evaluating the number of key combinations and their security level. To achieve the highest grade, the system must provide at least 100,000 effective differs, prevent direct key duplication, and comply with strict construction requirements.
- Attack resistance** - 5 grades: 0-A-B-C-D. These grades measure the cylinder's ability to resist burglary attempts, such as drilling, chisel attack, break, and plug extraction.
- Picking resistance** - Pass = resistance to manipulation using the picking technique.
- Bumping resistance** - 4 levels: 1-2-3-X. At Level X, the cylinder is bump-resistant and the test is not applicable. The other levels correspond to:
  - Level 1 = 5 minutes resistance and keys cut with all identical depths;
  - Level 2 = 10 minutes resistance and keys cut with all identical depths;
  - Level 3 = 15 minutes resistance and keys cut with different depths.

#### Example of cylinder classification

<b>1</b>	<b>6</b>	<b>0</b>	<b>B</b>	<b>0</b>	<b>C</b>	<b>6</b>	<b>D</b>
1	2	3	4	5	6	7	8
Use	Durability	Door mass	Fire resistance	Security	Corrosion resistance	Security of the key	Attack resistance

9 - **ANTI-PICKING:** Pass  
10 - **ANTI-BUMPING:** Level 2

*Note. The product certifications ICIM are available at the website [www.agb.it](http://www.agb.it)*

## UNI EN 1627:2021

### PEDESTRIAN DOORSETS - WINDOWS - CURTAIN WALLING - GRILLES AND SHUTTERS. BURGLAR RESISTANCE. REQUIREMENTS AND CLASSIFICATION.

- RC1 - RC1N:** minimum requirement according to UNI EN 1303:2015 / **Key-related security** = 4; **Attack resistance** = A
- RC2 - RC2N - RC3:** minimum requirement according to UNI EN 1303:2015 / **Key-related security** = 4; **Attack resistance** = C
- RC4:** minimum requirement according to UNI EN 1303:2015 / **Key-related security** = 6; **Attack resistance** = D
- RC5 - RC6:** minimum requirement according to UNI EN 1303:2015 / **Key-related security** = 6; **Attack resistance** = to be tested according to UNI EN 1630:2021

This products was made entirely in Italy. The design, production, processing and packaging are carried out exclusively on the Italian territory, into the AGB plants.

100% MADE IN ITALY



Open, Close, Live

Alban Giacomo SpA  
Via A. De Gasperi, 75  
36060 Romano d'Ezzelino (VI) Italy  
+39 0424 832 832  
[www.agb.it](http://www.agb.it) - [info@agb.it](mailto:info@agb.it)

MADE IN ITALY